

KAC-7201/7251

SERVICE MANUAL

© 2002-12 PRINTED IN JAPAN
B53-0021-00 (N) 3379

DRESSING PANEL
KAC-7251
(A21-4268-03)
KAC-7201
(A21-4269-03)

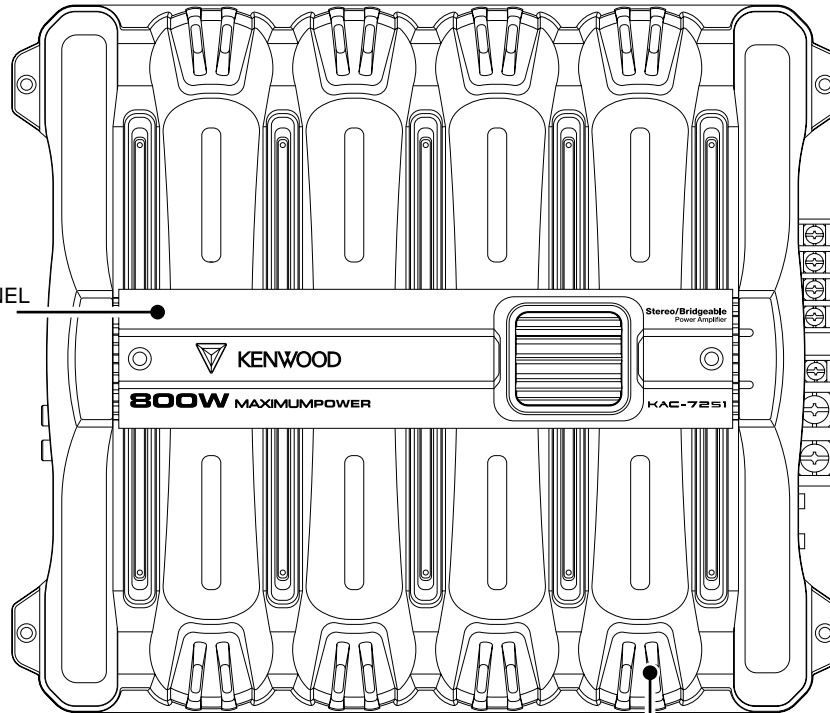

HEAT SINK
(F01-1727-01)

Illustration is KAC-7251.

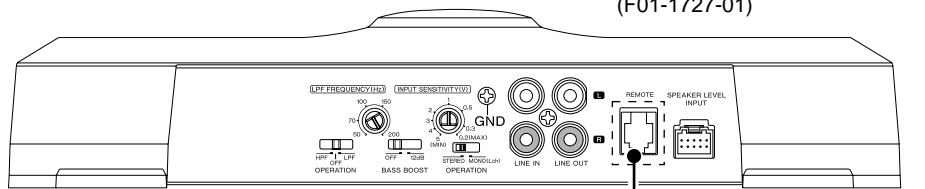

KAC-7251 only

LINE INPUT SIDE

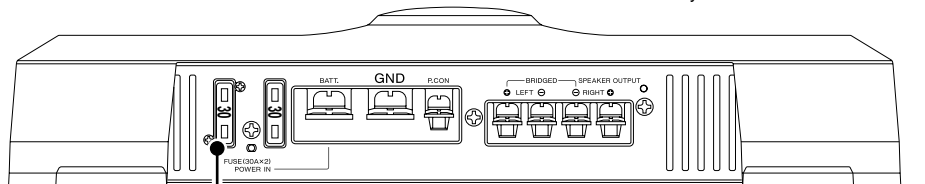

FUSE
(F52-0015-05)

SPEAKER OUTPUT SIDE

CONNECTING CORD ASSY
(E30-6145-05)

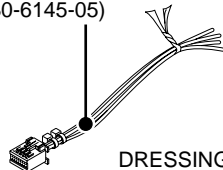

ACCESSORY
(W01-1606-05)

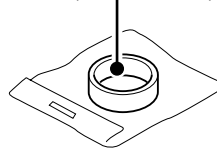

SCREW SET
(N99-1587-05)

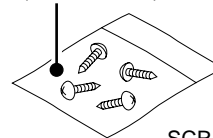

MODULAR CABLE
(E30-6240-05)
KAC-7251 only

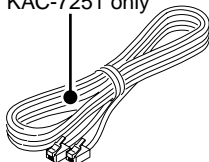

DRESSING PLATE
(B03-5024-04)
KAC-7251 only

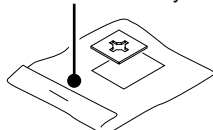

KNOB
(K23-1076-03)
KAC-7251 only



CONTROL ASSY
KAC-7251 only

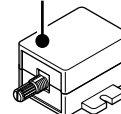

SCREW SET
(N99-1740-05)
KAC-7251 only

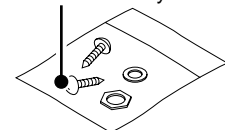

ADJUSTMENT

No.	ITEM	INPUT SETTINGS	OUTPUT SETTINGS	RECEIVER SETTINGS	ALIGNMENT POINTS	ALIGN FOR	FIG.
Connect a cassette receiver or CD receiver.							
1	IDLE CURRENT	-	Connect a DC voltmeter between check land A and B	VOLUME : 0	VR3 (L ch) VR4 (R ch)	2.5mV	A

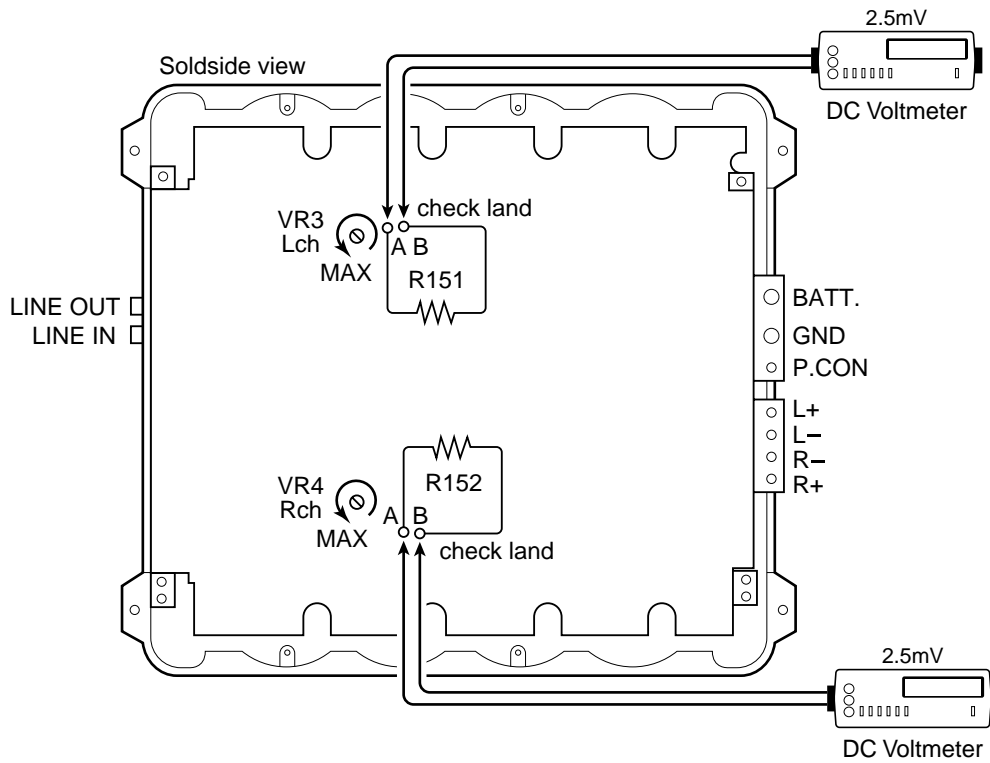

Fig. A

PC BOARD (FOIL SIDE VIEW)

KAC-7201/7251 KAC-7201/7251

SWITCH UNIT
X16-2390-10 (J74-1534-02)

AUDIO UNIT X09-5600-1x A/2 (J74-1501-01)

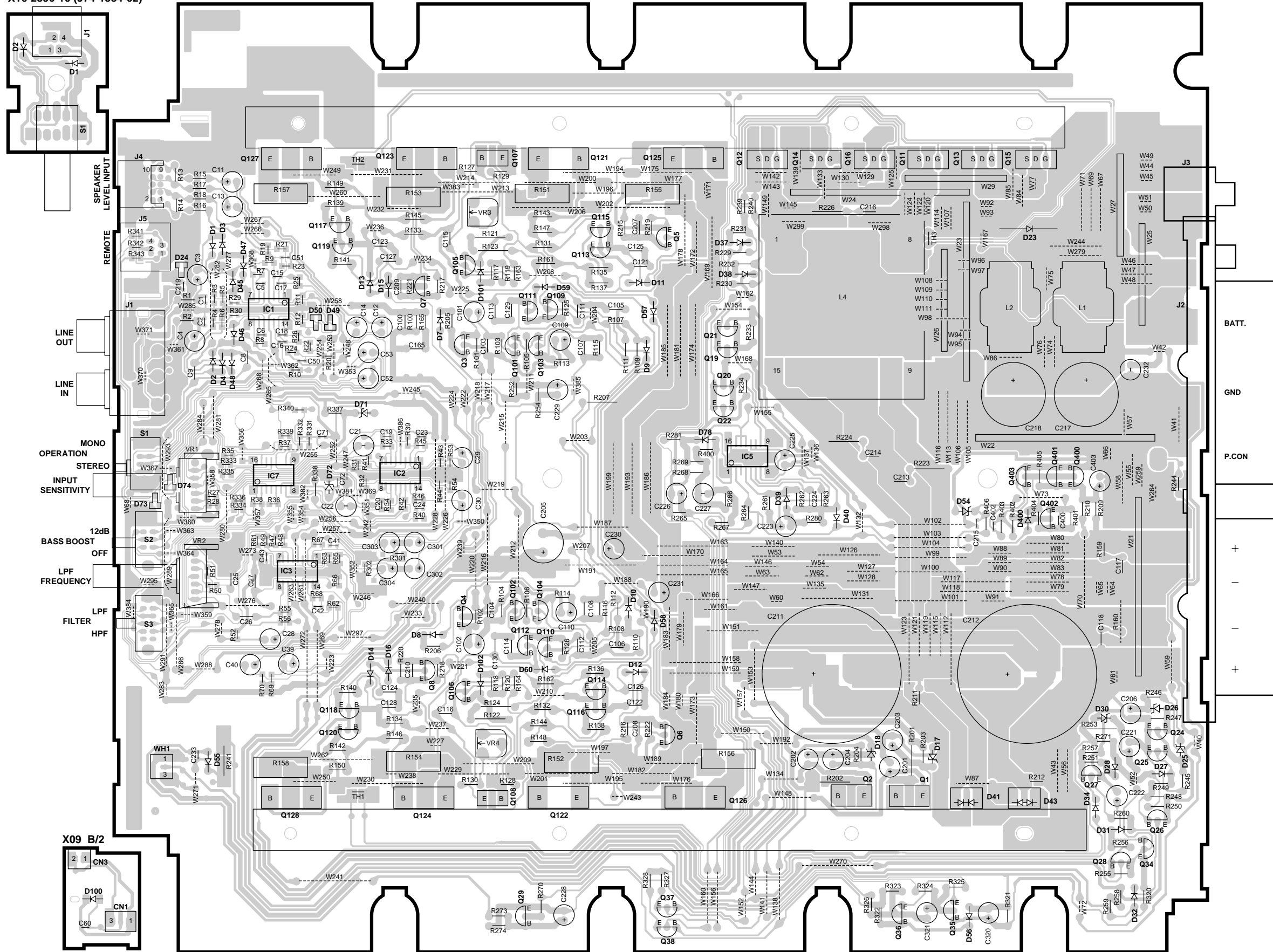

X09-5600-1x

IC	Q	Address	IC	Q	Address
1		3B		38	7E
2		4C		101	3D
3		5C		102	5D
5		4F		103	3D
7		4C		104	5D
	1	6G		105	3D
	2	6F		106	5D
	3	3D		107	2D
	4	5D		108	6D
	5	3E		109	3D
	6	6E		110	5D
	7	3C		111	3D
	8	5D		112	5D
	11	2G		113	3E
	12	2E		114	5E
	13	2G		115	3E
	14	2F		116	6D
	15	2G		117	3C
	16	2F		118	6C
	19	3E		119	3C
	20	4E		120	6C
	21	3E		121	2E
	22	4E		122	6D
	24	6H		123	2C
	25	6H		124	6C
	26	6H		125	2E
	27	6H		126	6E
	28	7H		127	2B
	29	7D		128	6C
	34	7H		400	4H
	35	7G		401	4G
	36	7F		402	4G
	37	7E		403	4G

Refer to the schematic diagram for the values of resistors and capacitors.

KAC-7201/7251 KAC-7201/7251

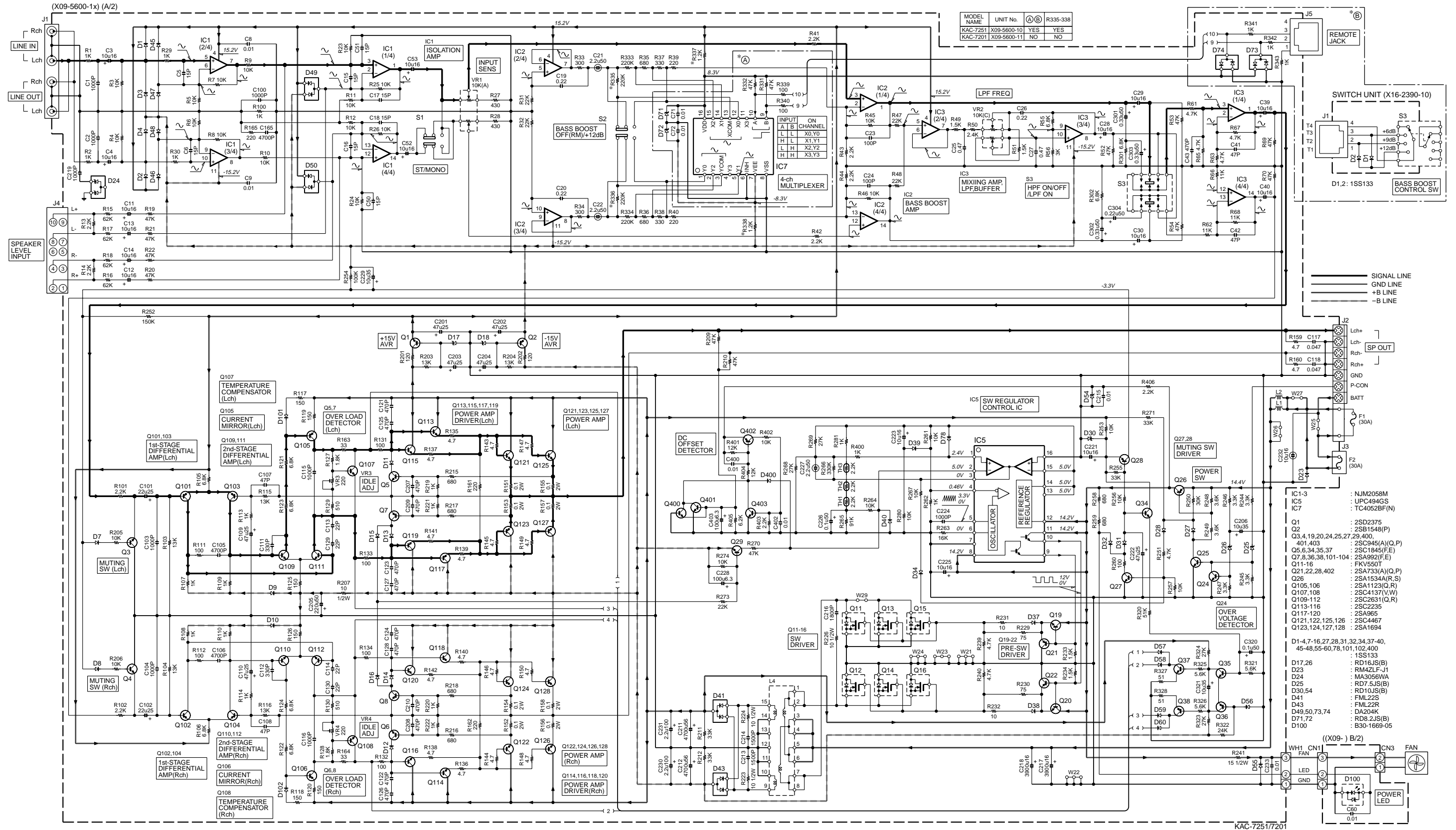

CAUTION : For continued safety, replace safety critical components only with manufacturer's recommended parts (refer to parts list).
 ⚠ Indicates safety critical components. To reduce the risk of electric shock, leakage-current or resistance measurements shall be carried out (exposed parts are acceptably insulated from the supply circuit) before the appliance is returned to the customer.

• DC voltages are as measured with a high impedance voltmeter. Values may vary slightly due to variations between individual instruments or/and units.

2SA1123
 2SA1534A
 2SA733(A)
 2SA965
 2SA992
 2SC1845
 2SC2235

2SC2631
 2SC945(A)

2SC4467

2SC4137

2SB1548

TC4052BF

DA204K

UPC494GS

NJM2058M

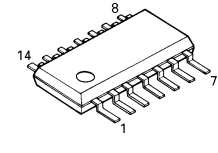
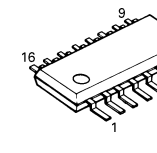
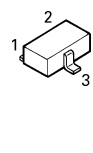
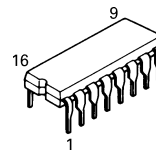
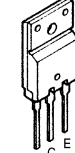
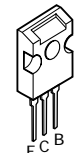
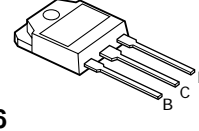
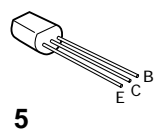

EXPLODED VIEW (UNIT)

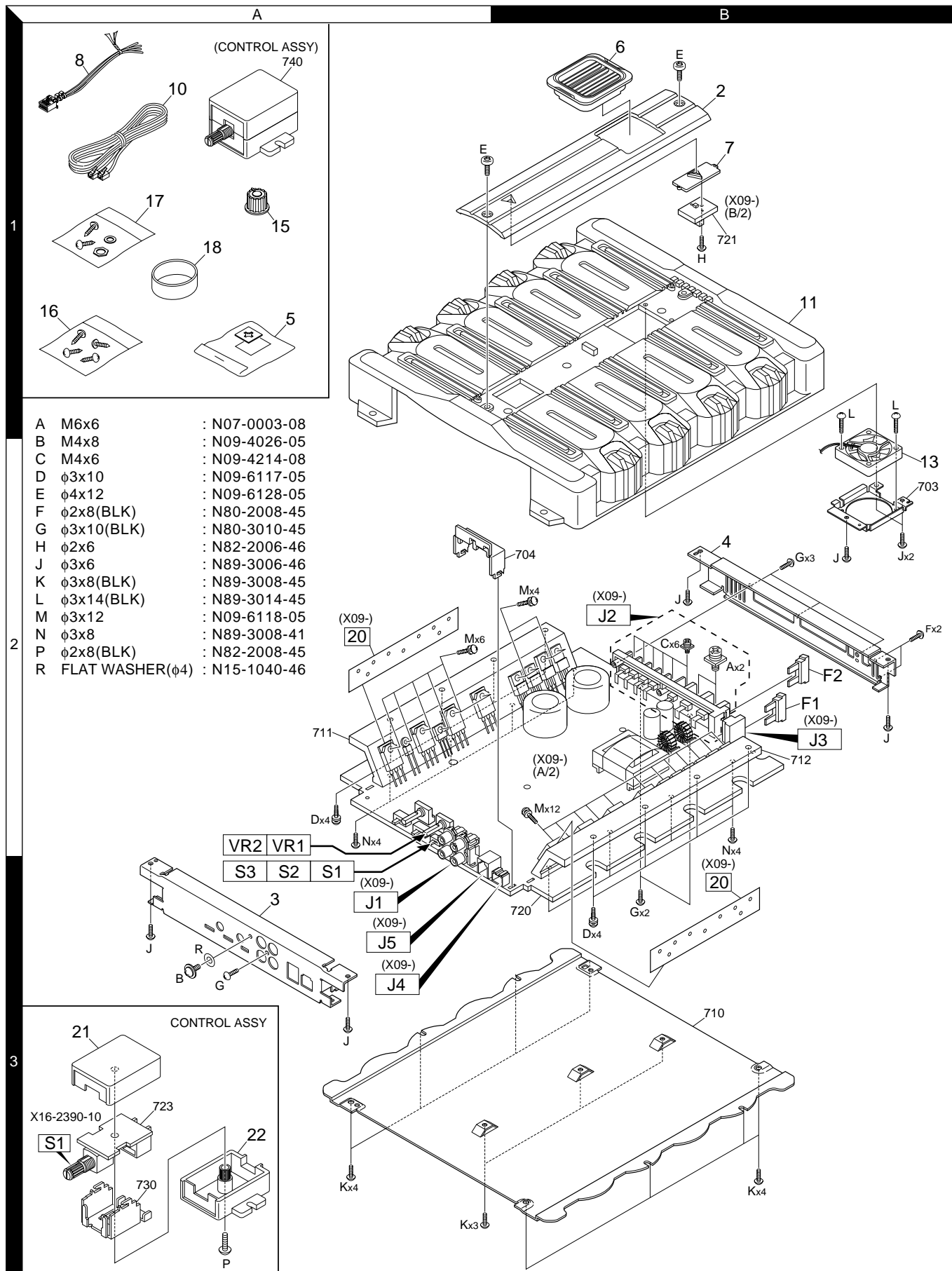

Parts with the exploded numbers larger than 700 are not supplied.

KAC-7201/7251

PARTS LIST

* New parts

Parts without **Parts No.** are not supplied.

Les articles non mentionnés dans le **Parts No.** ne sont pas fournis.

Teile ohne **Parts No.** werden nicht geliefert.

Ref. No.	Ad	New	Parts No.	Description	Destination	Ref. No.	Ad	New	Parts No.	Description	Destination
KAC-7201/7251											
2	1B	*	A21-4268-03	DRESSING PANEL	K1E1	C11-14			CE04DW1C100M	ELECTRO	10UF 16WV
2	1B	*	A21-4269-03	DRESSING PANEL	K2E2M	C15-18			CC73GCH1H150J	CHIP C	15PF J
3	3A	*	A64-3051-02	PANEL	K1E1	C19,20			CK73FB1C224K	CHIP C	0.22UF K
3	3A	*	A64-3052-02	PANEL	K2E2M	C21,22			CE04HW1H2R2M	NP-ELEC	2.2UF 50WV
4	2B	*	A84-0346-02	REAR PANEL		C23,24			CC73GCH1H101J	CHIP C	100PF J
5	1A	*	B03-5024-04	DRESSING PLATE	K1E1	C25			CF92FV1H474J	MF-C	0.47UF J
6	1B	*	B07-3084-02	ESCUTCHEON		C26			CF92FV1H224J	MF-C	0.22UF J
7	1B	*	B19-2214-03	LIGHTING BOARD		C27			CF92FV1H474J	MF-C	0.47UF J
-			B46-0100-50	WARRANTY CARD		C28-30			CE04DW1C100M	ELECTRO	10UF 16WV
-		*	B64-2569-00	INST. MANUAL (ENG,FRE,SPA)	K1E1	C39,40			CE04DW1C100M	ELECTRO	10UF 16WV
-		*	B64-2569-00	INST. MANUAL (ENG,FRE,SPA)	K2E2	C41,42			CC73GCH1H470J	CHIP C	47PF J
-		*	B64-2570-00	INST. MANUAL (GER,DUT,ITA,POR)	E1E2	C43			CC73GCH1H471J	CHIP C	470PF J
-		*	B64-2571-00	INST. MANUAL (ENG,T-CHI)	M	C50,51			CC73GCH1H150J	CHIP C	15PF J
8	1A		E30-6145-05	CONNECTING CORD ASS'Y		C52,53			CE04DW1C100M	ELECTRO	10UF 16WV
10	1A	*	E30-6240-05	MODULAR CABLE	K1E1	C60			CK73GB1H103K	CHIP C	0.010UF K
11	1B	*	F01-1727-01	HEAT SINK		C71,72			CK73GB1H103K	CHIP C	0.010UF K
13	2B	*	F09-1824-05	FAN		C100			CF92FV1H102J	MF-C	1000PF J
△ F1,2	2B	*	F52-0015-05	FUSE (BLADE TYPE : 30A)		C101,102			CE04DW1E220M	ELECTRO	22UF 25WV
-		*	H10-4870-03	POLYSTYRENE FOAMED FIXTURE		C103,104			CK45FB1H102K	CERAMIC	1000PF K
-			H21-1117-04	PROTECTION SHEET		C105,106			CF92FV1H472J	MF-C	4700PF J
-			H25-0336-04	PROTECTION BAG		C107,108			CC45FSL1H470J	CERAMIC	47PF J
-			H25-1179-04	PROTECTION BAG	K1E1	C109,110			CE04DW1E470M	ELECTRO	47UF 25WV
-		*	H30-0578-04	ADHESIVE DOUBLE-COATED TAPE	K1E1	C111,112			CC45FSL1H331J	CERAMIC	330PF J
-		*	H54-2876-03	ITEM CARTON CASE	K1E1	C113,114			CC45FSL1H220J	CERAMIC	22PF J
-		*	H54-2877-03	ITEM CARTON CASE	K2E2	C115,116			CF92FV1H102J	MF-C	1000PF J
-		*	H54-2878-03	ITEM CARTON CASE	M	C117,118			CF92FV1H473J	MF-C	0.047UF J
15	1A	*	K23-1076-03	KNOB	K1E1	C121-128			CC45FSL1H471J	CERAMIC	470PF J
16	1A		N99-1587-05	SCREW SET		C129,130			CC45FSL1H220J	CERAMIC	22PF J
17	1A		N99-1740-05	SCREW SET	K1E1	C165			CF92FV1H472J	MF-C	4700PF J
A	2B		N07-0003-08	SCREW (M6)		C201-204			CE04DW1E470M	ELECTRO	47UF 25WV
B	3A		N09-4026-05	TAPPING SCREW		C205			CE04DW1H221M	ELECTRO	220UF 50WV
C	2B		N09-4214-08	SCREW (M4)		C206			CE04DW1V100M	ELECTRO	10UF 35WV
D	2B	*	N09-6117-05	TAPTITE SCREW		C207-210			CK45FB1H471K	CERAMIC	470PF K
E	1B	*	N09-6128-05	DRESSED SCREW		C211,212			C90-5445-05	ELECTRO	4700UF 56WV
F	2B		N80-2008-45	PAN HEAD TAPTITE SCREW		C213,214			CF92FV1H152J	MF-C	1500PF J
G	2B		N80-3010-45	PAN HEAD TAPTITE SCREW		C215			CK73GB1H103K	CHIP C	0.010UF K
H	1B		N82-2006-46	BINDING HEAD TAPTITE SCREW		C216			CF92FV1H182J	MF-C	1800PF J
J	2B		N89-3006-46	BINDING HEAD TAPTITE SCREW		C217,218			C90-2921-05	ELECTRO	3900UF 16WV
K	3A		N89-3008-45	BINDING HEAD TAPTITE SCREW		C219			CK73GB1H102K	CHIP C	1000PF K
L	2B		N89-3014-45	BINDING HEAD TAPTITE SCREW		C221			CE04DW1C100M	ELECTRO	10UF 16WV
R	3A		N15-1040-46	FLAT WASHER		C22			CE04DW1E470M	ELECTRO	47UF 25WV
18	1A		W01-1606-05	ACCESSORY		C223			CE04DW1C100M	ELECTRO	10UF 16WV
740	1A	*	-	CONTROL ASS'Y	K1E1	C224			CF92FV1H102J	MF-C	1000PF J
-		*	X09-5600-10	AUDIO UNIT	K1E1	C225			CE04DW1C100M	ELECTRO	10UF 16WV
-		*	X09-5600-11	AUDIO UNIT	K2E2M	C226			CE04DW1H0R1M	ELECTRO	0.1UF 50WV
AUDIO UNIT (X09-5600-1x)											
C1,2			CK73GB1H102K	CHIP C	1000PF K	C227			CE04HW1H2R2M	NP-ELEC	2.2UF 50WV
C3,4			CE04DW1C100M	ELECTRO	10UF 16WV	C228			CE04DW0J101M	ELECTRO	100UF 6.3WV
C5,6			CC73GCH1H150J	CHIP C	15PF J	C229			CE04DW1V100M	ELECTRO	10UF 35WV
C8,9			CF92FV1H103J	MF-C	0.010UF J	C230,231		*	CE04DW2A2R2M	ELECTRO	2.2UF 100WV
						C232			CE04HW1C100M	NP-ELEC	10UF 16WV
						C233			CK73GB1H103K	CHIP C	0.010UF K
						C301-303			CE04DW1HR33M	ELECTRO	0.33UF 50WV
						C304			CE04DW1HR22M	ELECTRO	0.22UF 50WV
						C320			CE04DW1H0R1M	ELECTRO	0.1UF 50WV
						C321			CE04DW1V100M	ELECTRO	10UF 35WV

E1 : KAC-7251 (Europe) K1 : KAC-7251 (North America)

E2 : KAC-7201 (Europe) K2 : KAC-7201 (North America) M : KAC-7201 (Other Areas)

△ Indicates safety critical components.

PARTS LIST

* New parts

Parts without **Parts No.** are not supplied.

Les articles non mentionnés dans le **Parts No.** ne sont pas fournis.

Teile ohne **Parts No.** werden nicht geliefert.

AUDIO UNIT (X09-5600-1x)

Ref. No.	Add	New	Parts No.	Description	Destination	Ref. No.	Add	New	Parts No.	Description	Destination
C400			CK73GB1H103K	CHIP C 0.010UF K		R52-54			RK73FB2B473J	CHIP R 47K J 1/8W	
C402			CK73GB1H103K	CHIP C 0.010UF K		R55			RK73FB2B682J	CHIP R 6.8K J 1/8W	
C403			CE04DWOJ101M	ELECTRO 100UF 6.3WV		R56			RK73FB2B302J	CHIP R 3.0K J 1/8W	
CN1			E40-3247-05	PIN ASS'Y (3PIN)		R61			RK73FB2B472J	CHIP R 4.7K J 1/8W	
CN3			E40-3246-05	PIN ASS'Y (2PIN)		R62			RK73FB2B113J	CHIP R 11K J 1/8W	
J1		*	E63-0889-05	PIN JACK		R63			RK73FB2B472J	CHIP R 4.7K J 1/8W	
J2		*	E70-0838-05	SCREW TERMINAL BOARD		R65			RK73FB2B472J	CHIP R 4.7K J 1/8W	
J4		*	E58-0919-05	RECTANGULAR RECEPTACLE		R66			RK73FB2B113J	CHIP R 11K J 1/8W	
J5		*	E58-0966-05	RECTANGULAR RECEPTACLE	K1E1	R67			RK73FB2B472J	CHIP R 4.7K J 1/8W	
W21-24			E29-1863-05	LEAD PLATE		R68			RK73FB2B113J	CHIP R 11K J 1/8W	
W25-27			E29-1862-05	LEAD PLATE		R69,70			RK73FB2B473J	CHIP R 47K J 1/8W	
W29			E29-1862-05	LEAD PLATE		R100			RD14BB2C102J	RD 1.0K J 1/6W	
W40-197			E31-0001-00	JUMPER WIRE		R101,102			RD14BB2C222J	RD 2.2K J 1/6W	
W199-250			E31-0001-00	JUMPER WIRE		R103,104	*		RD14BB2C133J	RD 13K J 1/6W	
W252-254			E31-0001-00	JUMPER WIRE		R105,106			RD14BB2C682J	RD 6.8K J 1/6W	
W255			E31-0001-00	JUMPER WIRE	K1E1	R107-110			RD14BB2C102J	RD 1.0K J 1/6W	
W256-273			E31-0001-00	JUMPER WIRE		R111,112			RD14BB2C101J	RD 100 J 1/6W	
W276-286			E31-0001-00	JUMPER WIRE		R113,114			RD14BB2C102J	RD 1.0K J 1/6W	
W288,289			E31-0001-00	JUMPER WIRE		R115,116	*		RD14BB2C133J	RD 13K J 1/6W	
W291			E31-0001-00	JUMPER WIRE		R117-120	*		RD14BB2C151J	RD 150 J 1/6W	
W293			E31-0001-00	JUMPER WIRE		R121-124	*		RD14BB2E682J	RD 6.8K J 1/4W	
W295			E31-0001-00	JUMPER WIRE		R125,126	*		RD14BB2C151J	RD 150 J 1/6W	
W297-299			E31-0001-00	JUMPER WIRE		R127,128			RD14BB2C182J	RD 1.8K J 1/6W	
WH1		*	E39-0538-05	WIRING HARNESS		R129,130	*		RD14BB2C511J	RD 510 J 1/6W	
20	2A	*	F20-2244-04	INSULATING SHEET		R131-134			RD14NB2E101J	RD 100 J 1/4W	
J3		*	J13-0602-05	FUSE HOLDER		R135-150			RD14NB2E4R7J	RD 4.7 J 1/4W	
L1,2		*	L33-1920-05	CHOKE COIL		R151-158			R92-0205-05	METAL-PLATE 0.1 K 2W	
L4		*	L19-0743-05	TRANSFORMER FOR CONVERTER		R159,160			RD14NB2E4R7J	RD 4.7 J 1/4W	
G	2B		N80-3010-45	PAN HEAD TAPTITE SCREW		R161,162			RD14NB2E221J	RD 220 J 1/4W	
M	2A	*	N09-6118-05	TAPTITE SCREW		R163,164			RD14BB2C330J	RD 33 J 1/6W	
N	2B		N89-3008-41	BINDING HEAD TAPTITE SCREW		R165			RD14BB2C221J	RD 220 J 1/6W	
R1,2			RD14BB2C102J	RD 1.0K J 1/6W		R201,202	*		RD14BB2E121J	RD 120 J 1/4W	
R3-8			RK73FB2B103J	CHIP R 10K J 1/8W		R203,204	*		RD14BB2C133J	RD 13K J 1/6W	
R9-12			R92-3040-05	CHIP R 10K D 1/10W		R205,206			RD14BB2C103J	RD 10K J 1/6W	
R13,14			RD14BB2C222J	RD 2.2K J 1/6W		R207	*		RD14DB2H100J	SMALL-RD 10 J 1/2W	
R15-18		*	RD14BB2C623J	RD 62K J 1/6W		R209,210			RD14BB2C473J	RD 47K J 1/6W	
R19-22			RK73FB2B473J	CHIP R 47K J 1/8W		R211,212			RD14BB2C333J	RD 33K J 1/6W	
R23-26			R92-3040-05	CHIP R 10K D 1/10W		R215-218	*		RD14BB2C681J	RD 680 J 1/6W	
R27,28			RK73FB2B431J	CHIP R 430 J 1/8W		R219-222			RD14BB2C102J	RD 1.0K J 1/6W	
R29,30			RK73GB2A102J	CHIP R 1.0K J 1/10W		R223,224	*		RD14DB2H100J	SMALL-RD 10 J 1/2W	
R31,32			RK73FB2B223J	CHIP R 22K J 1/8W		R226	*		RD14DB2H100J	SMALL-RD 10 J 1/2W	
R33,34			RK73FB2B301J	CHIP R 300 J 1/8W		R229,230			RD14BB2C750J	RD 75 J 1/6W	
R35,36			RK73FB2B681J	CHIP R 680 J 1/8W		R231,232			RD14BB2C100J	RD 10 J 1/6W	
R37,38			RK73FB2B331J	CHIP R 330 J 1/8W		R233,234			RD14BB2C152J	RD 1.5K J 1/6W	
R39,40			RK73FB2B221J	CHIP R 220 J 1/8W		R239,240			RD14BB2C472J	RD 4.7K J 1/6W	
R41-44			RK73FB2B222J	CHIP R 2.2K J 1/8W		R241			RD14DB2H150J	SMALL-RD 15 J 1/2W	
R45,46			RK73FB2B103J	CHIP R 10K J 1/8W		R244-247			RD14BB2C332J	RD 3.3K J 1/6W	
R47,48			RK73FB2B223J	CHIP R 22K J 1/8W		R248,249	*		RD14BB2C362J	RD 3.6K J 1/6W	
R49			RK73FB2B152J	CHIP R 1.5K J 1/8W		R250			RD14BB2C303J	RD 30K J 1/6W	
R50		*	RK73FB2B242J	CHIP R 2.4K J 1/8W		R251			RD14BB2C472J	RD 4.7K J 1/6W	
R51			RK73FB2B152J	CHIP R 1.5K J 1/8W		R252	*		RD14BB2C154J	RD 150K J 1/6W	
						R253			RD14BB2E103J	RD 10K J 1/4W	
						R254			RD14BB2C104J	RD 100K J 1/6W	
						R255			RD14BB2C333J	RD 33K J 1/6W	
						R256,257			RD14BB2C103J	RD 10K J 1/6W	

E1 : KAC-7251 (Europe) K1 : KAC-7251 (North America)

E2 : KAC-7201 (Europe) K2 : KAC-7201 (North America) M : KAC-7201 (Other Areas)

△ Indicates safety critical components.

PARTS LIST

* New parts

Parts without **Parts No.** are not supplied.

Les articles non mentionnés dans le **Parts No.** ne sont pas fournis.

Teile ohne **Parts No.** werden nicht geliefert.

AUDIO UNIT (X09-5600-1x)

Ref. No.	A	N	Parts No.	Description	Desti-	Ref. No.	A	N	Parts No.	Description	Desti-
	d	e			nation		d	e			nation
R258,259		*	RD14BB2C681J	RD 680 J 1/6W		D1-4			1SS133	DIODE	
R260			RD14BB2C101J	RD 100 J 1/6W		D7-16			1SS133	DIODE	
R261			RD14BB2C103J	RD 10K J 1/6W		D17,18			RD16JS(B)	ZENER DIODE	
R262			RD14BB2C102J	RD 1.0K J 1/6W		D23			RM4ZLF-J1	DIODE	
R263		*	RD14BB2C163J	RD 16K J 1/6W		D24			MA3056WA	ZENER DIODE	
R264			RD14BB2C103J	RD 10K J 1/6W		D25			RD7.5JS(B)	ZENER DIODE	
R265		*	RD14BB2C913J	RD 91K J 1/6W		D26			RD16JS(B)	ZENER DIODE	
R266		*	RD14BB2C334J	RD 330K J 1/6W		D27,28			1SS133	DIODE	
R267			RD14BB2C103J	RD 10K J 1/6W		D30			RD10JS(B)	ZENER DIODE	
R268,269		*	RD14BB2C273J	RD 27K J 1/6W		D31,32			1SS133	DIODE	
R270			RD14BB2C473J	RD 47K J 1/6W		D34			1SS133	DIODE	
R271			RD14BB2C333J	RD 33K J 1/6W		D37-40			1SS133	DIODE	
R273			RD14BB2C223J	RD 22K J 1/6W		D41			FML22S	DIODE	
R274			RD14BB2C103J	RD 10K J 1/6W		D43			FML22R	DIODE	
R280			RD14BB2C103J	RD 10K J 1/6W		D45-48			1SS133	DIODE	
R281			RD14BB2C102J	RD 1.0K J 1/6W		D49,50			DA204K	DIODE	
R301,302			RK73FB2B682J	CHIP R 6.8K J 1/8W		D54			RD10JS(B)	ZENER DIODE	
R320		*	RD14BB2C513J	RD 51K J 1/6W		D55-60			1SS133	DIODE	
R321		*	RD14BB2C562J	RD 5.6K J 1/6W		D71,72			RD8.2JS(B)	ZENER DIODE	K1E1
R322			RD14BB2C243J	RD 24K J 1/6W		D73,74			DA204K	DIODE	K1E1
R323,324		*	RD14BB2C273J	RD 27K J 1/6W		D78			1SS133	DIODE	
R325,326		*	RD14BB2C562J	RD 5.6K J 1/6W		D100			B30-1669-05	LED	
R327,328		*	RD14BB2C510J	RD 51 J 1/6W		D101,102			1SS133	DIODE	
R331,332			RK73FB2B473J	CHIP R 47K J 1/8W	K1E1	D400			1SS133	DIODE	
R333,334			RK73FB2B224J	CHIP R 220K J 1/8W		IC-3			NJM2058M	IC (OP AMP)	
R335,336			RK73FB2B224J	CHIP R 220K J 1/8W	K1E1	IC5			UPC494GS	ANALOGUE IC	
R337,338		*	RD14BB2C122J	RD 1.2K J 1/6W	K1E1	IC7			TC4052BF(N)	MOS-IC	K1E1
R339,340			RK73FB2B101J	CHIP R 100 J 1/8W	K1E1	Q1			2SD2375	TRANSISTOR	
R341-343			RK73FB2B102J	CHIP R 1.0K J 1/8W	K1E1	Q2			2SB1548(P)	TRANSISTOR	
R400			RD14BB2C102J	RD 1.0K J 1/6W		Q3,4			2SC945(A)(Q,P)	TRANSISTOR	
R401		*	RD14BB2C123J	RD 12K J 1/6W		Q5,6			2SC1845(F,E)	TRANSISTOR	
R402			RD14BB2C103J	RD 10K J 1/6W		Q7,8			2SA992(F,E)	TRANSISTOR	
R403			RD14BB2C222J	RD 2.2K J 1/6W		Q11-16			FKV550T	FET	
R404		*	RD14BB2C123J	RD 12K J 1/6W		Q19,20			2SC945(A)(Q,P)	TRANSISTOR	
R405		*	RD14BB2C622J	RD 6.2K J 1/6W		Q21,22			2SA733(A)(Q,P)	TRANSISTOR	
R406			RD14BB2C222J	RD 2.2K J 1/6W		Q24,25			2SC945(A)(Q,P)	TRANSISTOR	
VR1			R31-0223-05	VARIABLE RESISTOR (100K : A)		Q26			2SA1534A(R,S)	TRANSISTOR	
VR2			R31-0229-05	VARIABLE RESISTOR (100K : C)		Q27			2SC945(A)(Q,P)	TRANSISTOR	
VR3,4			R12-0092-05	VARIABLE RESISTOR (220)		Q28			2SA733(A)(Q,P)	TRANSISTOR	
W350-353			R92-1252-05	CHIP R 0 OHM J 1/16W		Q29			2SC945(A)(Q,P)	TRANSISTOR	
W354,355			R92-2053-05	CHIP R 0 J 1/8W		Q34,35			2SC1845(F,E)	TRANSISTOR	
W356			R92-2053-05	CHIP R 0 J 1/8W	K1E1	Q36			2SA992(F,E)	TRANSISTOR	
W357,358			R92-1252-05	CHIP R 0 OHM J 1/16W		Q37			2SC1845(F,E)	TRANSISTOR	
W359,360			R92-2053-05	CHIP R 0 J 1/8W		Q38			2SA992(F,E)	TRANSISTOR	
W361-365			R92-1252-05	CHIP R 0 OHM J 1/16W		Q101-104			2SA992(F,E)	TRANSISTOR	
W367			R92-2053-05	CHIP R 0 J 1/8W		Q105,106			2SA1123(Q,R)	TRANSISTOR	
W368-370			R92-1252-05	CHIP R 0 OHM J 1/16W		Q107,108			2SC4137(V,W)	TRANSISTOR	
W371			R92-2053-05	CHIP R 0 J 1/8W		Q109-112			2SC2631(Q,R)	TRANSISTOR	
W381,382			R92-1252-05	CHIP R 0 OHM J 1/16W		Q113-116			2SC2235	TRANSISTOR	
W383-385			R92-2053-05	CHIP R 0 J 1/8W		Q117-120			2SA965	TRANSISTOR	
W386			R92-1252-05	CHIP R 0 OHM J 1/16W		Q121,122			2SC4467	TRANSISTOR	
S1			S62-0842-05	SLIDE SWITCH		Q123,124			2SA1694	TRANSISTOR	
S2			S62-0845-05	SLIDE SWITCH		Q125,126			2SC4467	TRANSISTOR	
S3			S31-2630-05	SLIDE SWITCH		Q127,128			2SA1694	TRANSISTOR	
						Q400,401			2SC945(A)(Q,P)	TRANSISTOR	

E1 : KAC-7251 (Europe) K1 : KAC-7251 (North America)

E2 : KAC-7201 (Europe) K2 : KAC-7201 (North America) M : KAC-7201 (Other Areas)

△ Indicates safety critical components.

PARTS LIST

* New parts

Parts without **Parts No.** are not supplied.

Les articles non mentionnés dans le **Parts No.** ne sont pas fournis.

Teile ohne **Parts No.** werden nicht geliefert.

AUDIO UNIT (X09-5600-1x)

Ref. No.	A d d	N e w	Parts No.	Description	Desti- nation
Q402			2SA733(A)(Q,P)	TRANSISTOR	
Q403			2SC945(A)(Q,P)	TRANSISTOR	
TH1,2			PTH9M04BD222T	POSITIVE RESISTOR	
TH3			PTH9L04BD222TS	POSITIVE RESISTOR	
SWITCH UNIT (X16-2390-10)					
J1		*	E58-0966-05	RECTANGULAR RECEPTACLE	K1E1
S1			S60-0807-05	ROTARY SWITCH	K1E1
D1,2			1SS133	DIODE	K1E1
CONTROL ASSY					
21	3A	*	A02-2728-02	PLASTIC CABINET	K1E1
22	3A	*	A02-2729-02	PLASTIC CABINET	K1E1
P	3A		N82-2008-45	BINDING HEAD TAPTITE SCREW	K1E1
-		*	X16-2390-10	SWITCH UNIT	K1E1

Ref. No.	A d d	N e w	Parts No.	Description	Desti- nation

E1 : KAC-7251 (Europe) K1 : KAC-7251 (North America)

E2 : KAC-7201 (Europe)

K2 : KAC-7201 (North America)

M : KAC-7201 (Other Areas)

△ Indicates safety critical components.

KAC-7201/7251

SPECIFICATIONS

Audio Section

Rated Power Output (4Ω 20Hz~20kHz)	150W x 2 (0.08% THD)
(4Ω DIN45324, +B=14.4V)	150W x 2
(2Ω 1kHz)	230W x 2 (0.8% THD)
Bridged Power Output	460W x 1 (0.8% THD)
Max Power Output	800W x 1
Low-Pass Filter	50~200Hz (18dB/oct.)
High-Pass Filter	150Hz (12dB/oct.)
Bass Boost Circuit (90Hz)	OFF/+6/+9/+12dB (KAC-7251)
	OFF/+12dB (KAC-7201)
Frequency Response (0dB, -3dB)	5Hz~50kHz
Signal to Noise Ratio	100dB
Sensitivity (Max.)	0.2V (Rated Output)
Sensitivity (Min.)	5.0V (Rated Output)
Input Impedance	10kΩ

General

Operating Voltage	14.4V (11V~16V allowable)
Current consumption (1kHz 10%THD)	43A
Installation Size (W x H x D)	285 x 57 x 305 mm
	(11-1/4 x 2-1/4 x 12 inch)
Weight	3.32kg

KENWOOD follows a policy of continuous advancements in development. For this reason specifications may be changed without notice.

KENWOOD CORPORATION

2967-3, Ishikawa-machi, Hachioji-shi, Tokyo 192-8525, Japan

KENWOOD USA CORPORATION
P.O. BOX 22745, 2201 East Dominguez Street, Long Beach, CA90801-5745, U.S.A.

KENWOOD ELECTRONICS CANADA INC.
6070 Kestrel Road, Mississauga, Ontario, Canada L5T 1S8

KENWOOD ELECTRONICS LATIN AMERICA S.A.
P.O. Box 55-2791 Paitilla, Plaza Credicorp Bank Panama,
Piso 9, Oficina 901, Calle 50, Panama, Rep. de Panama

KENWOOD ELECTRONICS BRASIL LTDA.
Alameda Ministro Rocha Azevedo No. 456,
Edifício Jaú, 10o Andar, Cerqueira César, Cep 0140-001,
São Paulo-SP-Brasil

KENWOOD ELECTRONICS UK LIMITED
Kenwood House, Dwight Road, Watford, Herts, WD18 9EB, United Kingdom

KENWOOD ELECTRONICS DEUTSCHLAND GMBH
Rembrücker-Str. 15, 63150 Heusenstamm, Germany

KENWOOD ELECTRONICS FRANCE S.A.
13, Boulevard Ney, 75018 Paris, France

KENWOOD ELECTRONICS BELGIUM N.V.
Leuvensesteenweg 248 J, 1800 Vilvoorde, Belgium

KENWOOD ELECTRONICS ITALIA S.p.A.
Via G. Sirtori 7/9, 20129 Milano, Italy

KENWOOD IBÉRICA S.A.
Bolivia, 239-08020 Barcelona, Spain

KENWOOD ELECTRONICS AUSTRALIA PTY. LTD. (A.C.N. 001 499 074)
16 Giffnock Avenue, Centrecourt Estate, North Ryde,
N.S.W. 2113, Australia

KENWOOD ELECTRONICS (HONG KONG) LTD.
Unit 3712-3724, Level 37, Tower 1, Metroplaza, 223 Hing Fong Road, Kwai Fong, N.T.,
Hong Kong

KENWOOD ELECTRONICS GULF FZE
P.O. Box 61318, Jebel Ali, Dubai, U.A.E.

KENWOOD ELECTRONICS (THAILAND) CO., LTD.
2019 New Pechburi Road, Bangkok, Huaykwang, Bangkok, 10320 Thailand

KENWOOD ELECTRONICS SINGAPORE PTE. LTD.
1 Genting Lane, #07-00, Kenwood Building, Singapore, 349544

KENWOOD ELECTRONICS (MALAYSIA) SDN BHD
#4.01 Level 4, Wisma Academy Lot 4A, Jalan 19/1, 46300 Petaling Jaya, Selangor Darul Ehsan,
Malaysia